

Varenummer: 03446120  
Beskrivelse: Fluro Heavy Duty Ledleje GE 120 GW-2RS  
Hul Ø120  
Note: 120

## Mål

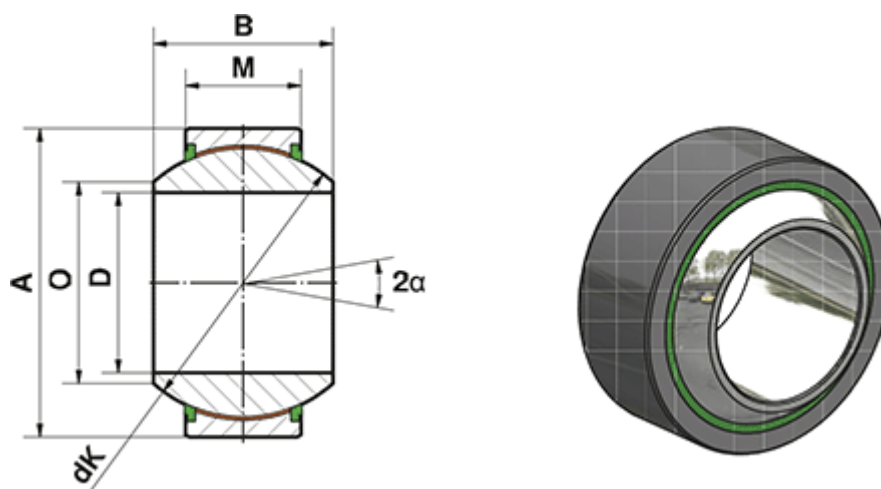

= -	Dynamisk belastning C (kN) = 3015
= -	M = 70
= -	O = 138.4
A = 210	Statisk belastning C0 (kN) = 5025
a (grader) = 16	Vægt (g) = 14600
B = 115	
D = 120	
dK = 180	